

AC11004 WiFi Tri-Band FPC Antenna

The AC11004 tri-band flexible embedded WiFi antenna supports the 2.4 GHz, 5 GHz and 6 GHz WiFi bands (2.4-2.5 GHz, 5.15-7.125 GHz). The flexibility and peel-and-stick adhesive backing make the AC11004 antenna easy to mount in unique and custom enclosures.

Connection is made to the radio via a 1.13 mm coaxial cable terminated in a U.FL-type plug connector. Various cable length options are available (See Ordering Information).



AC11004-100
WiFi 7 Tri-Band FPC Antenna

Features

- Very high efficiency
- Ground plane independent
- Compact I-shape form factor
 - 45.0 mm x 10.0 mm x 0.27 mm
- Performance at 2.4 GHz to 2.5 GHz
 - VSWR: 1.5
 - Peak Gain: 2.9 dBi
 - Efficiency: 75%
- Performance at 5.15 GHz to 5.85 GHz
 - VSWR: 1.8
 - Peak Gain: 6.4 dBi
 - Efficiency: 70%
- Performance at 5.925 GHz to 7.125 GHz
 - VSWR: 1.8
 - Peak Gain: 6.0 dBi
 - Efficiency: 75%
- MHF1/U.FL compatible plug termination

Applications

- WiFi/WLAN Coverage
 - WiFi 7 (802.11be)
 - WiFi 6E (802.11ax)
 - WiFi 6 (802.11ax)
 - WiFi 5 (802.11ac)
 - WiFi 4 (802.11n)
 - 802.11b/g
- 2.4 GHz ISM applications
 - Bluetooth®
 - ZigBee®
- U-NII bands 1-8
- Internet of Things (IoT) devices
- WLAN Gateways/Routers
- Fixed Wireless Customer Premise Equipment (CPE)

Ordering Information

Part Number	Cable Length	Connector
AC11004-050UF	50 mm (1.97 in)	MHF1/U.FL-type plug (male)
AC11004-100UF	100 mm (3.94 in)	MHF1/U.FL-type plug (male)
AC11004-150UF	150 mm (5.91 in)	MHF1/U.FL-type plug (male)
AC11004-200UF	200 mm (7.87 in)	MHF1/U.FL-type plug (male)

Available from The Antenna Company (sales@antennacompany.com) and select distributors and representatives.

RF/Electrical Specifications

AC11004	ISM/WiFi	WiFi/U-NII 1-4	WiFi/U-NII 5-8
Parameter	2400 MHz to 2500 MHz	5150 MHz to 5850 MHz	5900 MHz to 7150 MHz
VSWR (max)	1.5	1.8	1.8
Peak Gain (dBi)	2.9	6.4	6.0
Average Gain (dBi)	-1.4	-1.8	-1.8
Average Efficiency (%)	72	66	67
Impedance	50 Ω		
Polarization	Linear		
Radiation Pattern	Omnidirectional		
Wavelength	$\frac{1}{2}$ -wave		
Max Power	2 W		
Electrical Type	Dipole		

Electrical specifications and plots measured with the antenna mounted on a 2 mm (0.08 in) thick sheet of ABS plastic.

Mechanical Specifications

Part Number	AC11004-050UF	AC11004-100UF	AC11004-150UF	AC11004-200UF
Weight	0.3 g (0.01 oz)	0.4 g (0.01 oz)	0.5 g (0.02 oz)	0.6 g (0.02 oz)
Coaxial cable, minimum inside bend radius	1.13 mm: 5.0 mm (0.20 in)			
Connection	MHF1/U.FL-type plug (male)			
Dimensions	45.0 mm x 10.0 mm x 0.27 mm (01.77 in x 0.39 in x 0.01 in)			
Operating Temp. Range	-40 °C to +85 °C (-40 °F to 185 °F)			
Recommended Storage Conditions	16° C - 27° C and 40% to 60% relative humidity			

Antenna Mounting

The AC11004 antenna is a flexible, adhesive-backed antenna that allows it to be permanently installed onto non-metallic surfaces. The adhesive backing is 3M 467MP™, which provides outstanding adhesion to high surface energy plastics. The adhesive delivers excellent shear strength to resist slippage and edge lifting, but can be repositioned before the adhesive cures, allowing for accurate positioning. This adhesive is highly resistant to solvents, humidity and moisture, as well as heat up to 204 °C (400 °F) for short periods.

The antenna should never be bent to the point of creating a crease or allowing the angle of the bend to fall below 90 degrees (i.e. become acute) as this will impair function and may cause permanent damage.

Antenna Dimensions

The dimensions for the AC11004 are shown below in Figure 1.

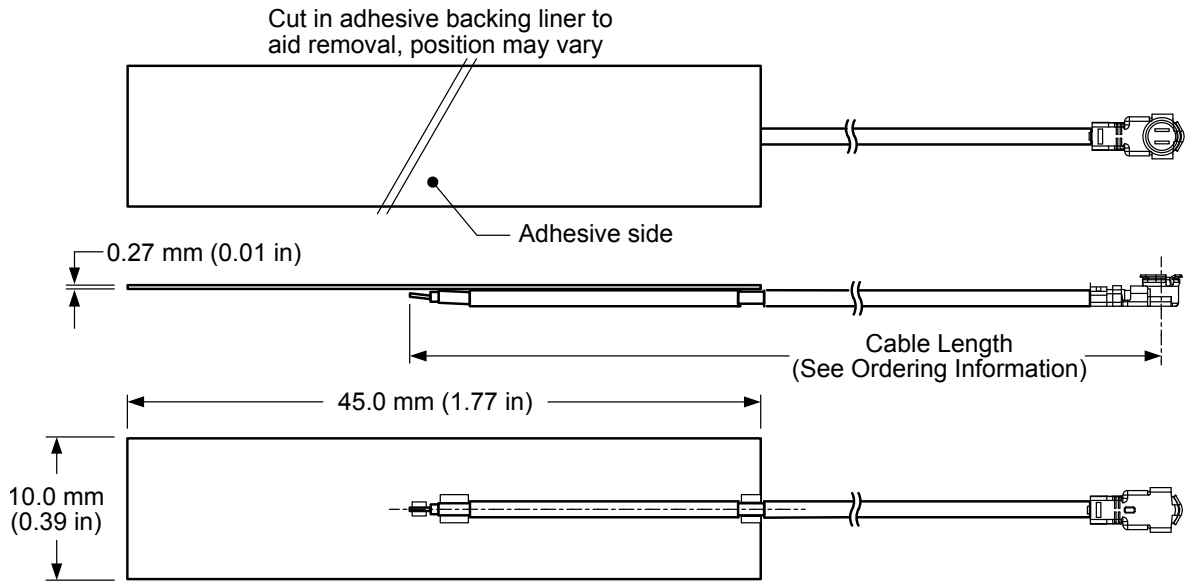

Figure 1. AC11004 Antenna Dimensions

VSWR

Figure 2 provides the voltage standing wave ratio (VSWR) across the antenna bandwidth. VSWR characterizes the power reflected from the antenna back to the transmitter. A lower VSWR value indicates better antenna performance at a given frequency. Reflected power is also shown on the right-side vertical axis as a measure of the percentage of transmitter power reflected back from the antenna.

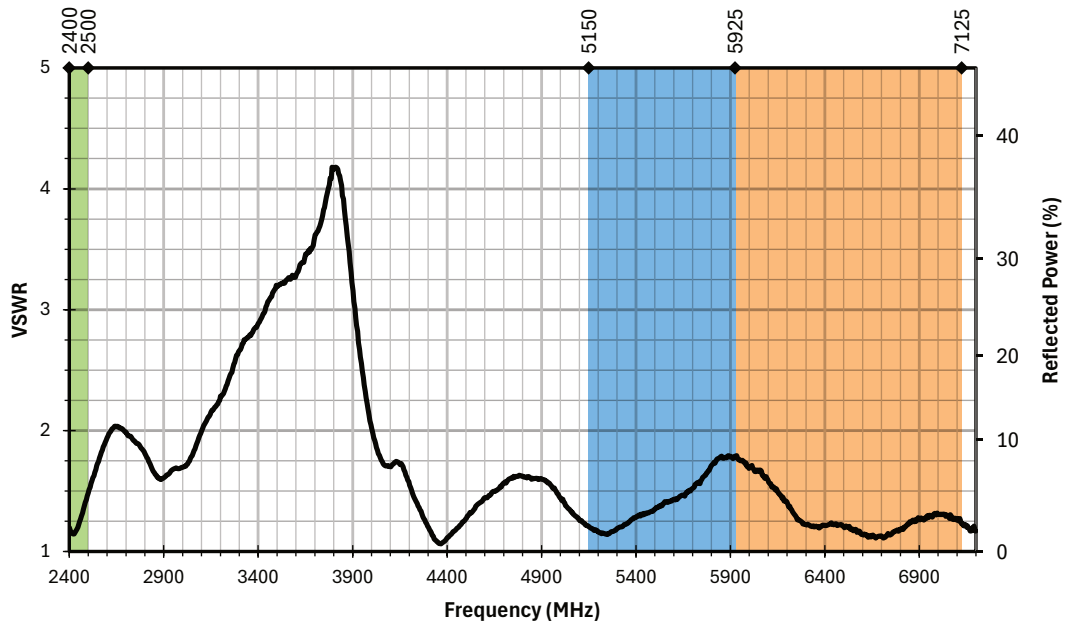

Figure 2. AC11004 Antenna VSWR

Return Loss

Return loss (Figure 3) represents the loss in power at the antenna due to reflected signals. A higher magnitude return loss indicates better performance. Return loss is the negative of input reflection coefficient, in decibels (dB), and the two values are often used interchangeably.

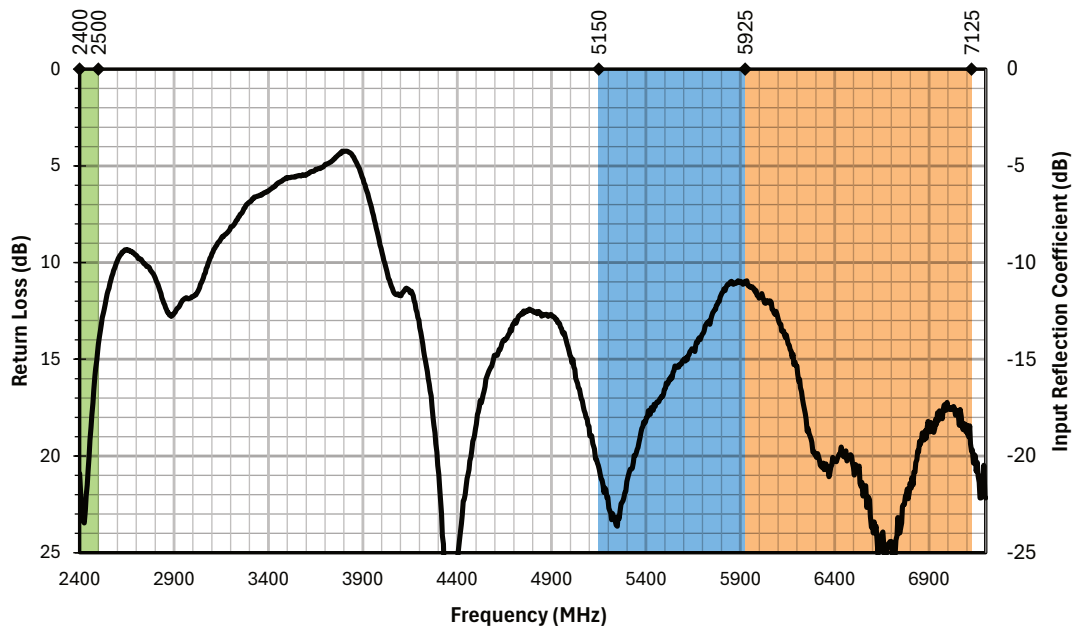

Figure 3. AC11004 Antenna Return Loss

Peak Gain

Peak gain (Figure 4) provides a measure of the maximum conversion of antenna input power to radio waves at a given frequency. Peak gain does not account for the directionality of gain in 3-dimensional space.

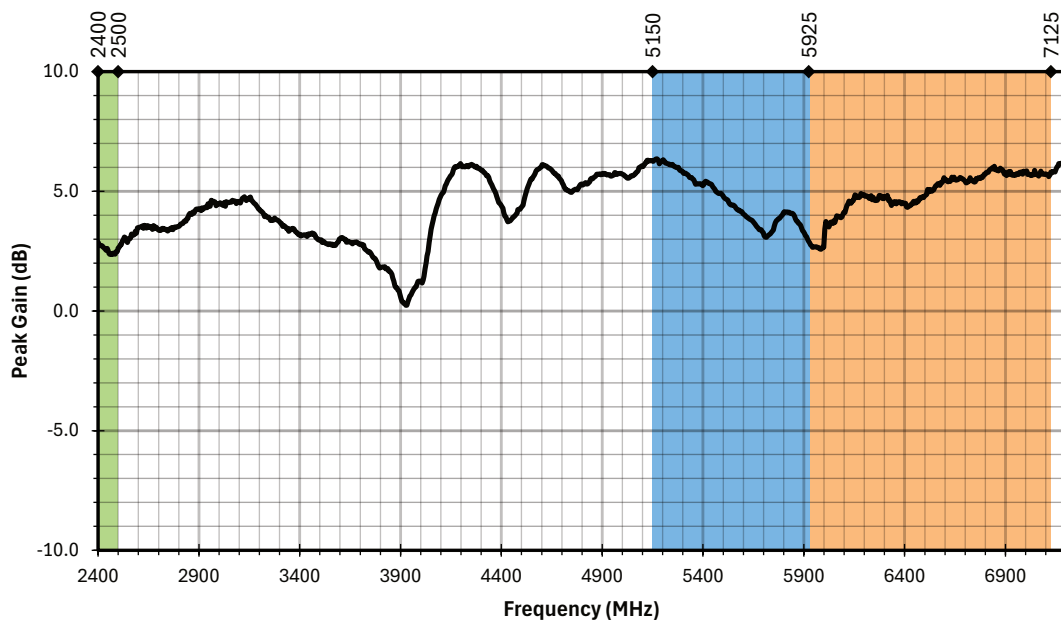

Figure 4. AC11004 Antenna Peak Gain

Average Gain

Average gain (Figure 5) is the average of all antenna gain in 3-dimensional space at each frequency, providing an indication of overall performance without expressing antenna directionality.

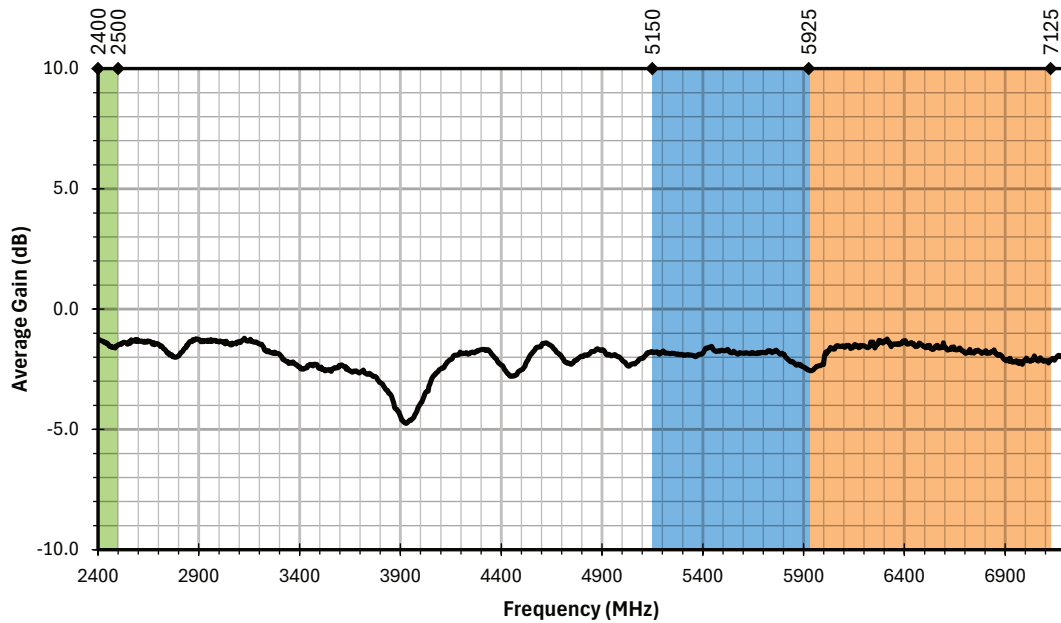

Figure 5. AC11004 Antenna Average Gain

Efficiency

Efficiency (Figure 6) is the ratio of power delivered to the antenna relative to the power radiated at the antenna, expressed as a percentage, where a higher percentage indicates better performance at a given frequency.

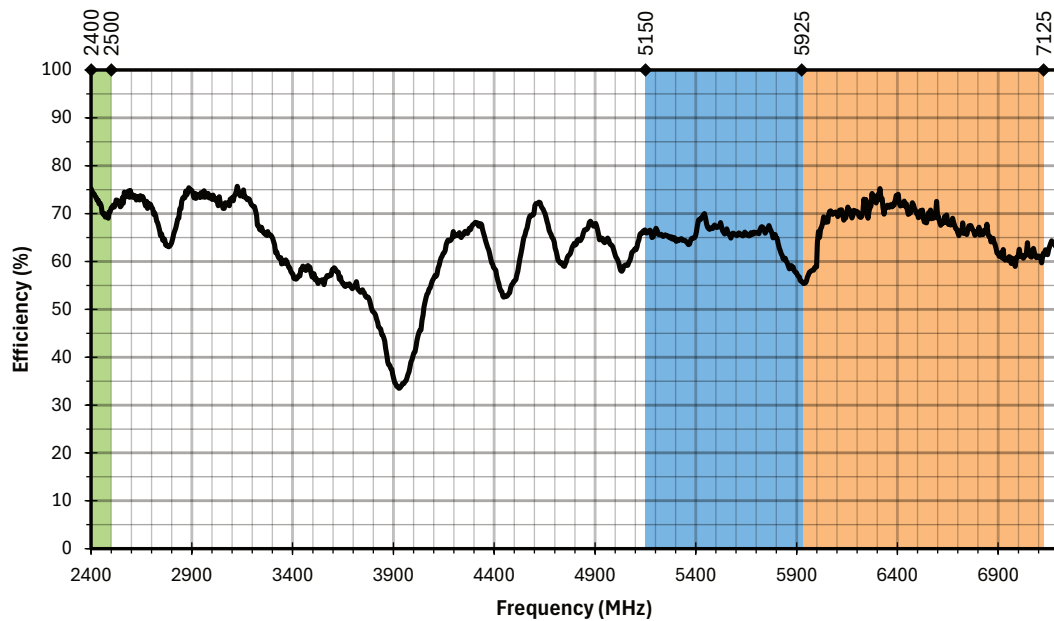

Figure 6. AC11004 Antenna Efficiency

Radiation Patterns

Radiation patterns provide information about the directional performance of the antenna by plotting gain in three orthogonal planes at the high-, low- and center-frequencies of an antenna frequency band. Antenna radiation patterns (Figure 7) are shown using polar plots covering 360 degrees with the plane of reference depicted above the plots. Note: when viewed with typical PDF viewing software, zooming into radiation patterns is possible to reveal fine detail.



2400 MHz to 2500 MHz (2450 MHz)

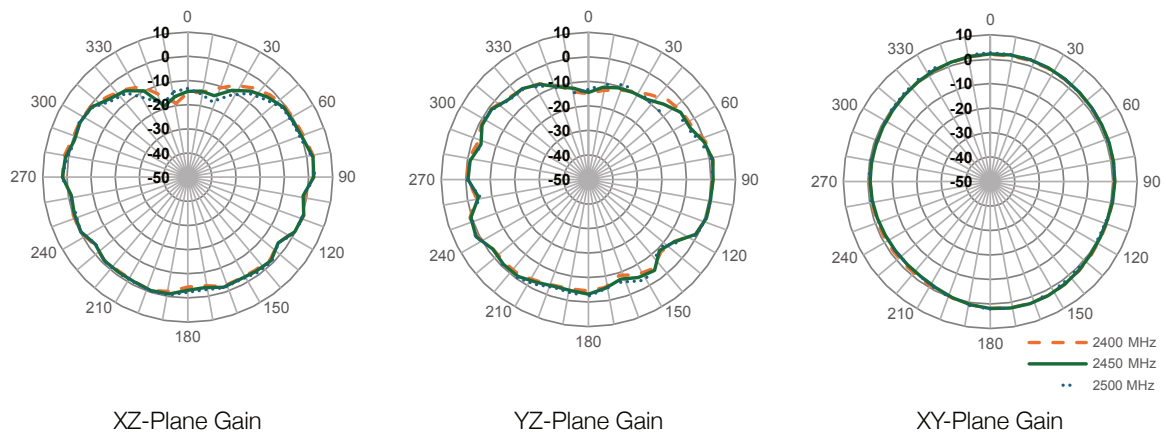

5150 MHz to 5895 MHz (5520 MHz)

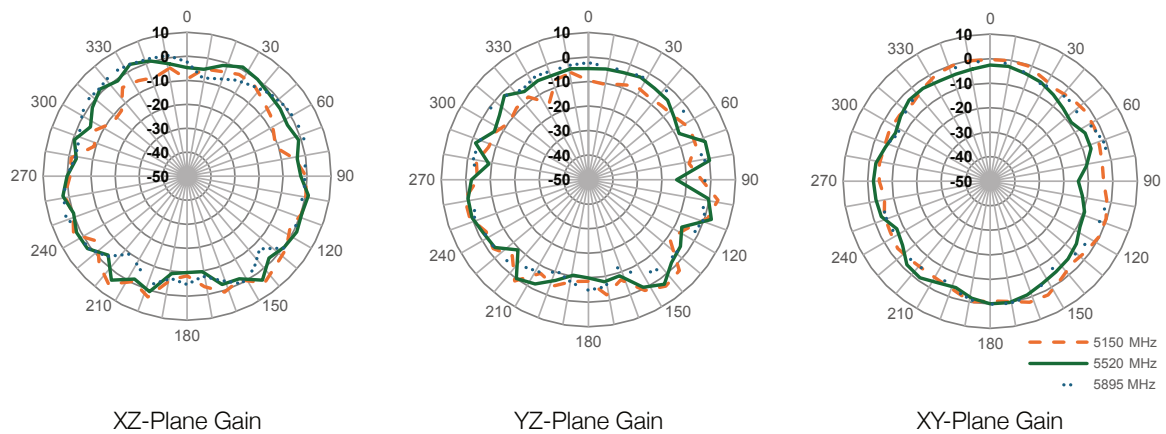

Radiation Patterns

5925 MHz to 7125 MHz (6525 MHz)

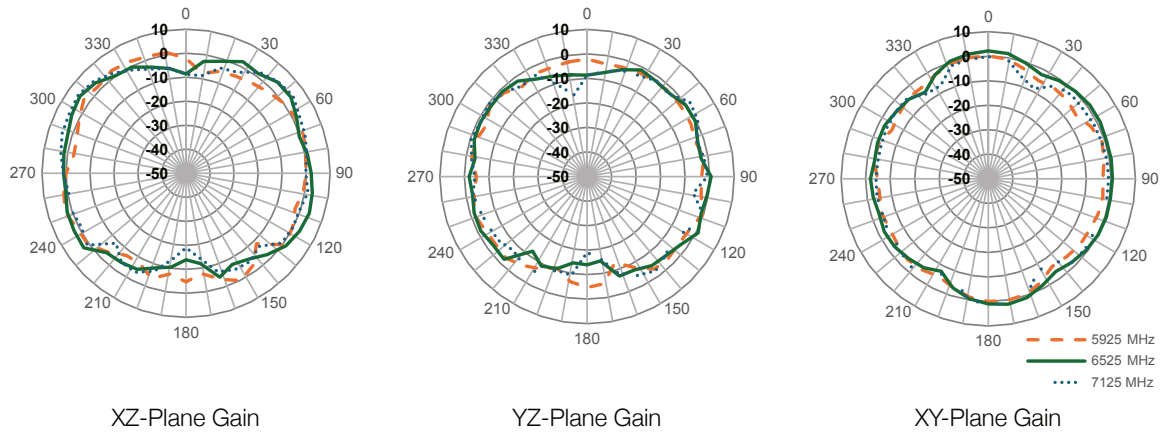

Figure 7. Radiation Patterns for the AC11004 Antenna

Packaging Information

The AC11004 antenna is individually packaged in a labeled polyethylene bag and then bulk packaged in a polyethylene bag in quantities of 50 pcs. Sealed bulk polyethylene bags are packed in cartons in quantities of 160 yielding 8000 pieces per carton. Carton dimensions are 340 mm x 340 mm x 200 mm (13.4 in x 13.4 in x 7.9 in).

Website: <http://www.antennacompany.com>
Offices: Eindhoven, The Netherlands
EMAIL: sales@antennacompany.com

The Antenna Company reserves the right to make changes to the product(s) or information contained herein without notice. No liability is assumed as a result of their use or application. No rights under any patent accompany the sale of any such product(s) or information.

Bluetooth is a registered trademark of Bluetooth SIG, Inc. ZigBee is a registered trademark of ZigBee Alliance, Inc. Other product and brand names may be trademarks or registered trademarks of their respective owners.

Series: FPC

Copyright © 2026 The Antenna Company International N.V.

All Rights Reserved

DOC# DS26015-041ANT

