

AC65001-NJ

Low Power Wide Area (LPWA) Compact Dome Panel-Mount Antenna

The AC65001-NJ N-connector dome antennas provide robust compact, outdoor, omnidirectional low power wide area (LPWA) antenna solutions for unlicensed applications including WiFi HaLow and LoRaWAN. Each antenna supports IP67 and IP65 ingress protection as well as IK-10 impact resistance, all under an attractive, UV-resistant, dome. The 82 mm x 40mm mounted size combines excellent antenna performance with a compact low-profile that fits in many applications from mobile/vehicular roof-mount to fixed vending machine use, and supports use on both metal enclosures or in free space including non-metallic enclosures.

The AC65001-NJ compact dome antennas are available in two colors, black and white, with fine matte finish, and two termination options: 24mm N-connector jack, and 14mm N-connector jack for thin/limited area mounts. Similar-performing NMO-terminated (AC65001-NM) and cabled (AC67001) compact dome antennas are also available.



AC65001-NJW Compact Dome Panel-Mount Antenna

Features

- Very high efficiency
 - 868 MHz band efficiency: 87%
 - 915 MHz band efficiency: 90%
- IP67/IP65 ingress protection
- IK10 impact resistance
- O-ring mounting seal
- UV resistance
- Salt spray resistance
- Ground plane independent
- Dimensions: 82 mm x 40 mm
- 24 mm and 14 mm N-connector termination options

Applications

- Unlicensed low power wide area networking (LPWAN) applications
 - WiFi HaLow®
 - LoRaWAN®
- 868 MHz and 915 MHz band applications
- Industrial, scientific and medical (ISM) applications
- Internet of Things (IoT) devices
- Gateways/Routers
- Automotive/vehicular/OHV

Ordering Information

Part Number	Description
AC65001-NJB	Black 24 mm N-connector jack LPWA compact dome antenna
AC65001-NJW	White 24 mm N-connector jack LPWA compact dome antenna
AC65001-2NJB	Black 14 mm N-connector jack LPWA compact dome antenna
AC65001-2NJW	White 14 mm N-connector jack LPWA compact dome antenna

See the AC67001 compact dome antennas for cabled options and AC65001-NM for NMO termination options. Available from The Antenna Company (sales@antennacompany.com) and select distributors and representatives.

Electrical Specifications

AC66001-NPW	868 MHz	915 MHz
Parameter	863 MHz to 870 MHz	902 MHz to 928 MHz
VSWR (max)	1.9	2.4
Peak Gain (dBi)	3.4	4.0
Average Gain (dBi)	-0.6	-0.4
Average Efficiency (%)	87	90
Impedance	50 Ω	
Polarization	Linear	
Radiation Pattern	Omnidirectional	
Wavelength	½-wave	
Maximum Input Power	10W	
Electrical Type	Dipole	

Electrical specifications and plots measured with the antenna mounted at the center of a 300 mm x 300 mm ground plane.

Mechanical Specifications

Parameter	Value
Antenna Connection (Termination)	N Jack, 24 mm or 14 mm
Available Panel Mount Thickness (washer, nut and N plug attached)	AC65001-NJx = 10 mm AC65001-2NJx = 1.5 mm
Mounting torque	1.0 - 1.5 Nm
Weight	AC65001-NJx = 119.07 g (4.2 oz) AC65001-2NJx = 107.73 g (3.8 oz)
Dimensions (mounted)	82.0 mm x Ø40.0 mm (3.23 in x Ø1.57 in)

Environmental Specifications

Parameter	Value
Operating Temp. Range	-40 °C to +85 °C (-104 °F to 185 °F)
Operating Relative Humidity	≤ 98%
Ingress Protection	IP67, IP65
Impact Resistance	IK10
Flammability Rating	UL 94-HB
Salt Spray	MIL-STD 810F/STM B117
Wind Resistance (max.)	300 km/hr (186 mi/hr)

Antenna Dimensions

The dimensions for the AC65001-NJ are shown below in Figure 1.

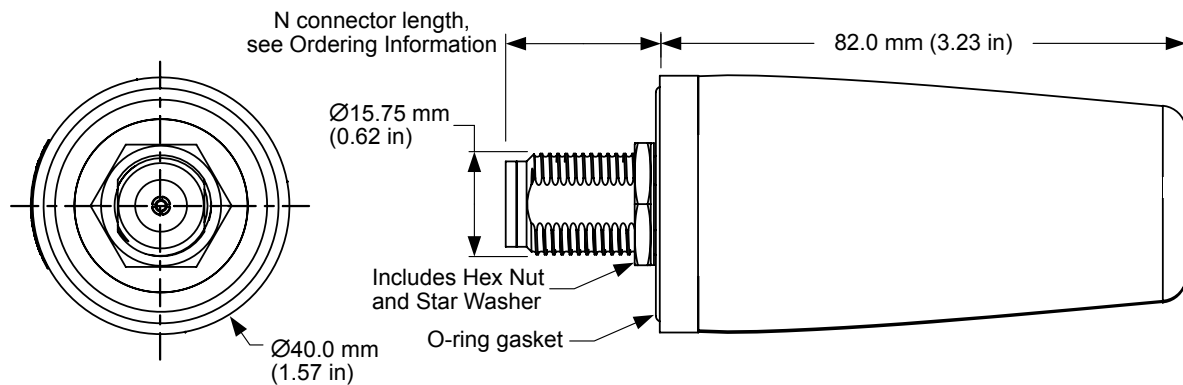

Figure 1. AC65001-NJ Antenna Dimensions

Mounting Dimensions

The mounting dimensions for the AC65001-NJ antennas are shown in Figure 2.

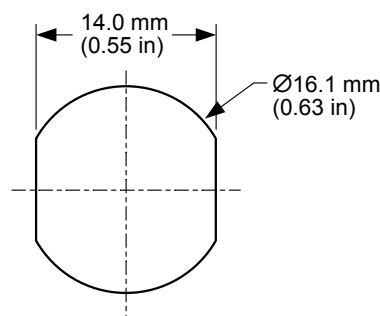

Figure 2. AC65001-NJ Antenna Mounting Dimensions

Antenna Test Orientations

The AC65001-NJ antenna is characterized in two antenna orientations as shown in Figure 3. Although the antenna does not require a ground plane to function, characterization on an adjacent ground plane (300 mm x 300 mm) provides insight into antenna performance when attached directly on a metal enclosure. The antenna free space orientation characterizes use of an antenna attached to a non-metallic enclosure. These two orientations represent common end-product use cases.

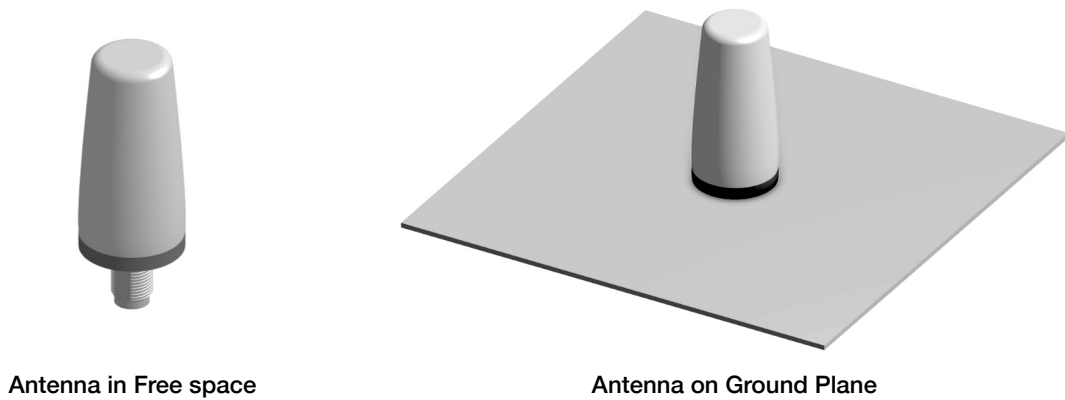

Figure 3. AC65001-NJ Antenna Test Orientations

On Ground Plane

The charts on the following pages represent data taken with the antenna oriented at the center of the 300 mm x 300 mm metal plate as shown in Figure 4.

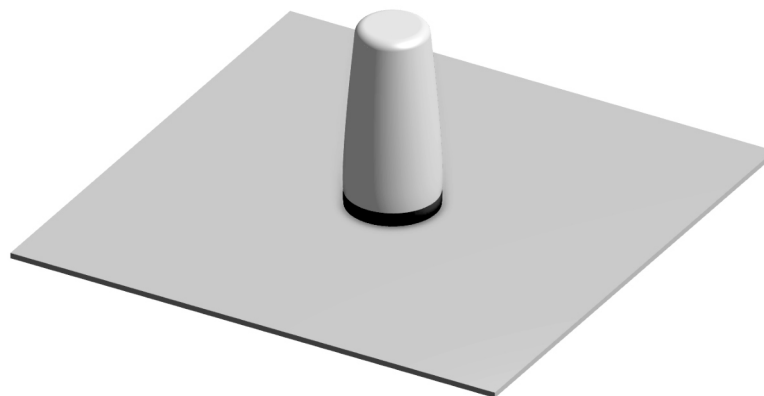

Figure 4. AC65001-NJ Antenna On Ground Plane

VSWR

Figure 5 provides the voltage standing wave ratio (VSWR) across the antenna bandwidth. VSWR characterizes the power reflected from the antenna back to the transmitter. A lower VSWR value indicates better antenna performance at a given frequency. Reflected power is also shown on the right-side vertical axis as a measure of the percentage of transmitter power reflected back from the antenna.

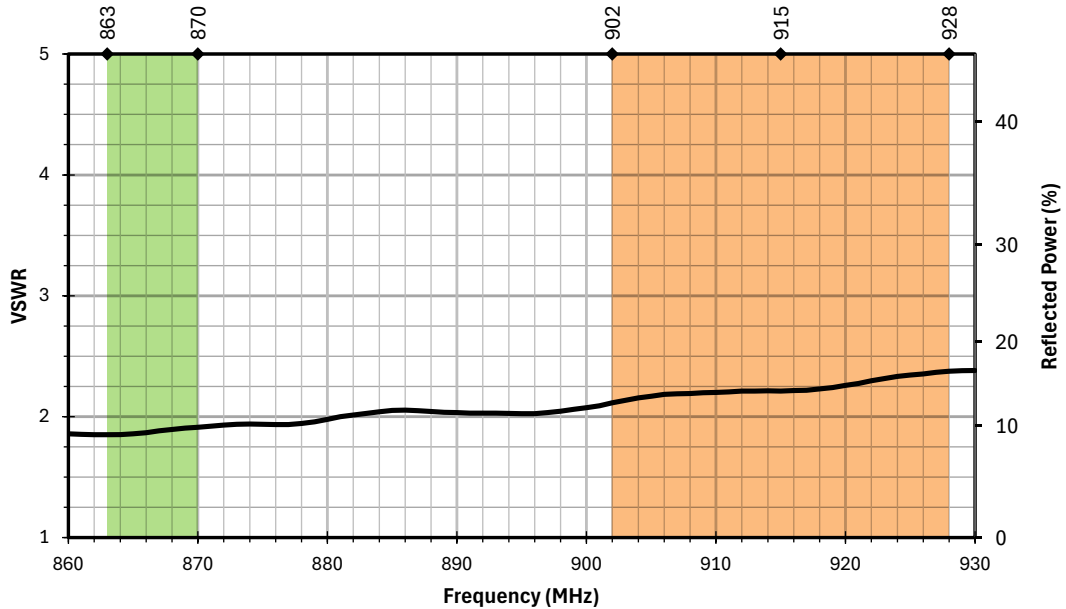

Figure 5. AC65001-NJ Antenna VSWR on Ground Plane

Return Loss

Return loss (Figure 6) represents the loss in power at the antenna due to reflected signals. A higher magnitude return loss indicates better performance. Return loss is the negative of input reflection coefficient, in decibels (dB), and the two values are often used interchangeably.

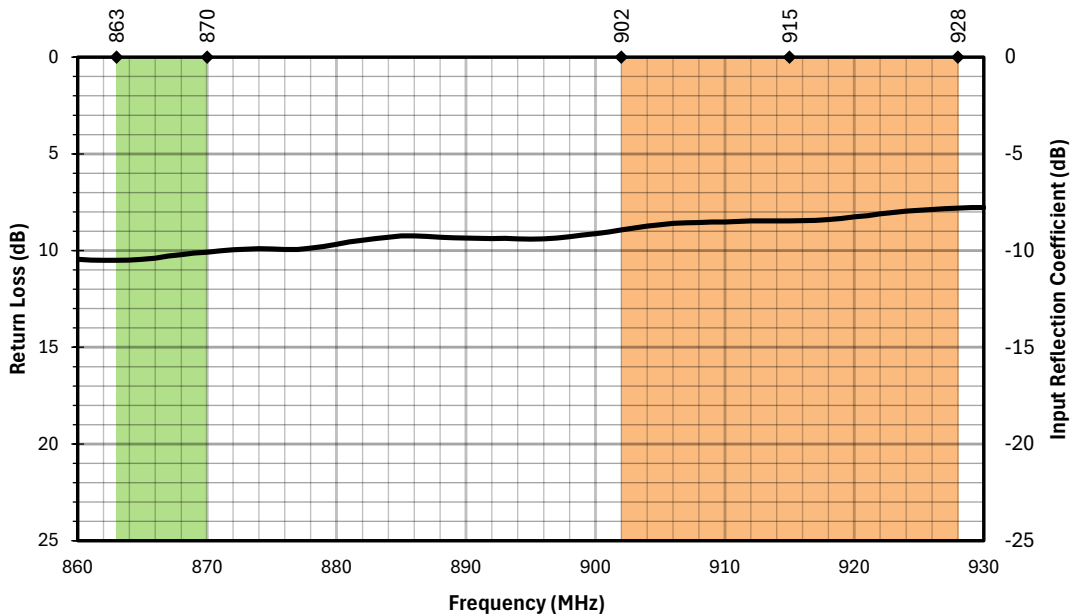

Figure 6. AC65001-NJ Antenna Return Loss on Ground Plane

Peak Gain

Peak gain (Figure 7) provides a measure of the maximum conversion of antenna input power to radio waves at a given frequency. Peak gain does not account for the directionality of gain in 3-dimensional space.

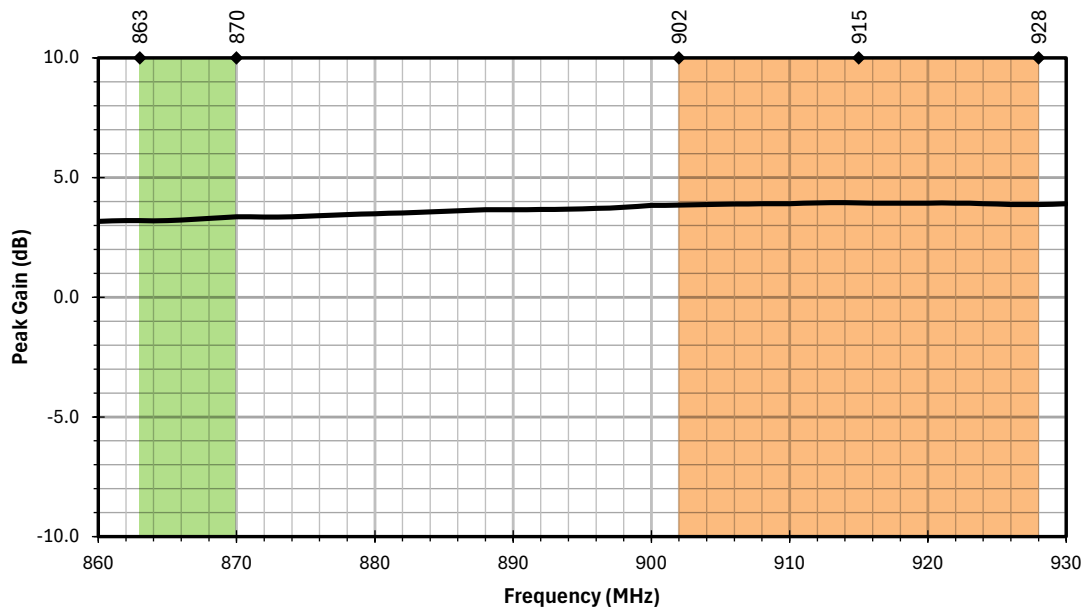

Figure 7. AC65001-NJ Antenna Peak Gain on Ground Plane

Average Gain

Average gain (Figure 8) is the average of all antenna gain in 3-dimensional space at each frequency, providing an indication of overall performance without expressing antenna directionality.

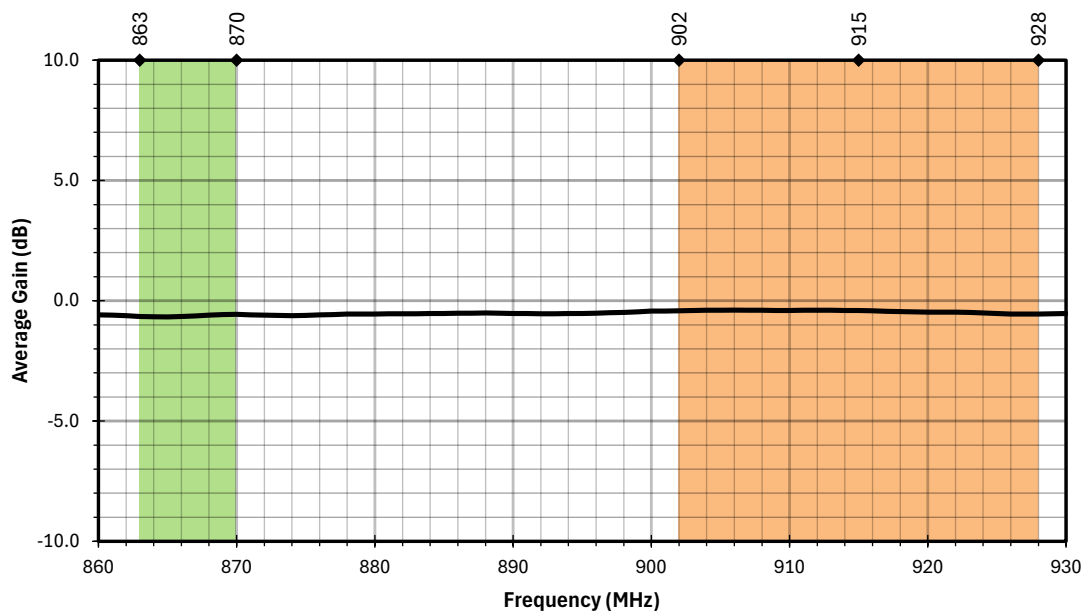

Figure 8. AC65001-NJ Antenna Average Gain on Ground Plane

Efficiency

Efficiency (Figure 9) is the ratio of power delivered to the antenna relative to the power radiated at the antenna, expressed as a percentage, where a higher percentage indicates better performance at a given frequency.

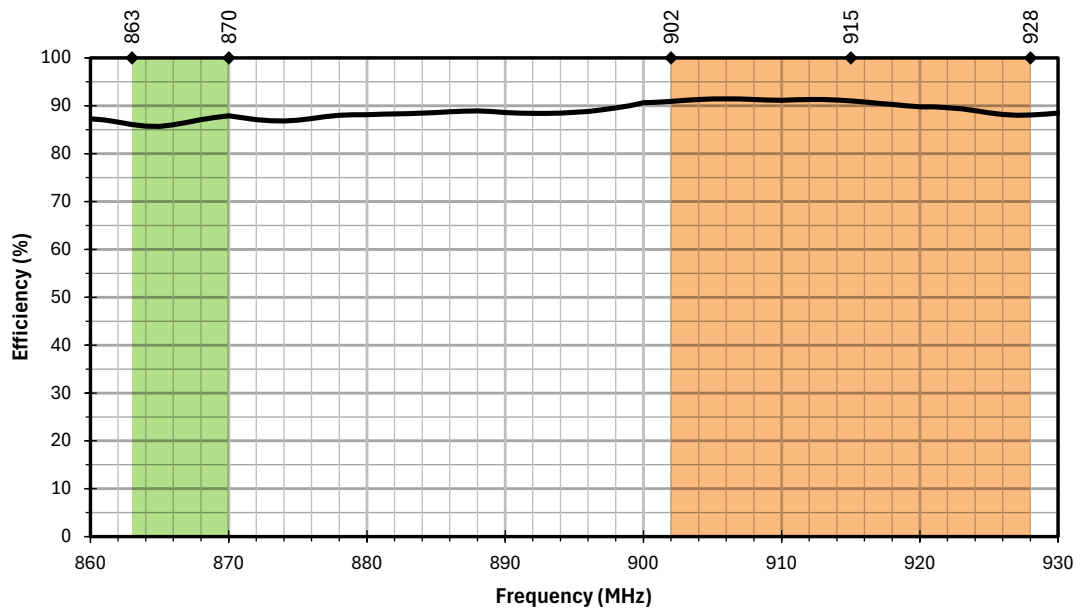
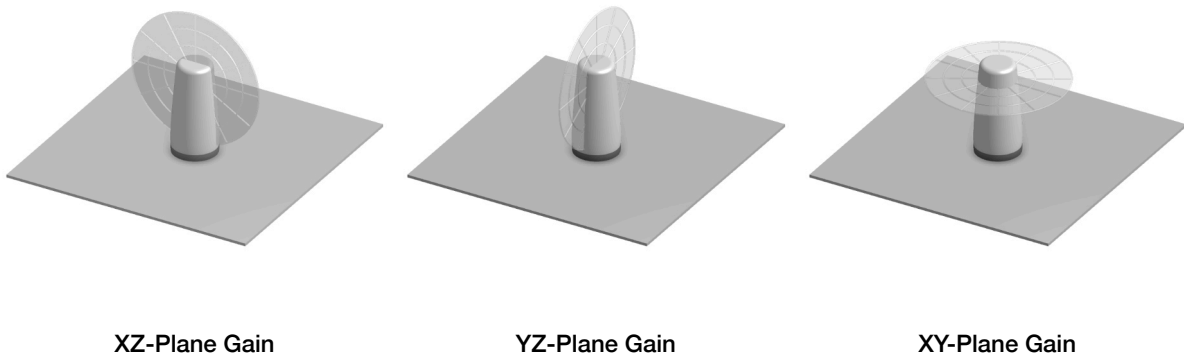

Figure 9. AC65001-NJ Antenna Efficiency on Ground Plane

Radiation Patterns - On Ground Plane

Radiation patterns provide information about the directional performance of the antenna by plotting gain in three orthogonal planes at the high-, low- and center-frequencies of an antenna frequency band. Antenna radiation patterns (Figure 10) are shown using polar plots covering 360 degrees with the plane of reference depicted above the plots. Note: when viewed with typical PDF viewing software, zooming into radiation patterns is possible to reveal fine detail.



863 MHz to 870 MHz (867 MHz)

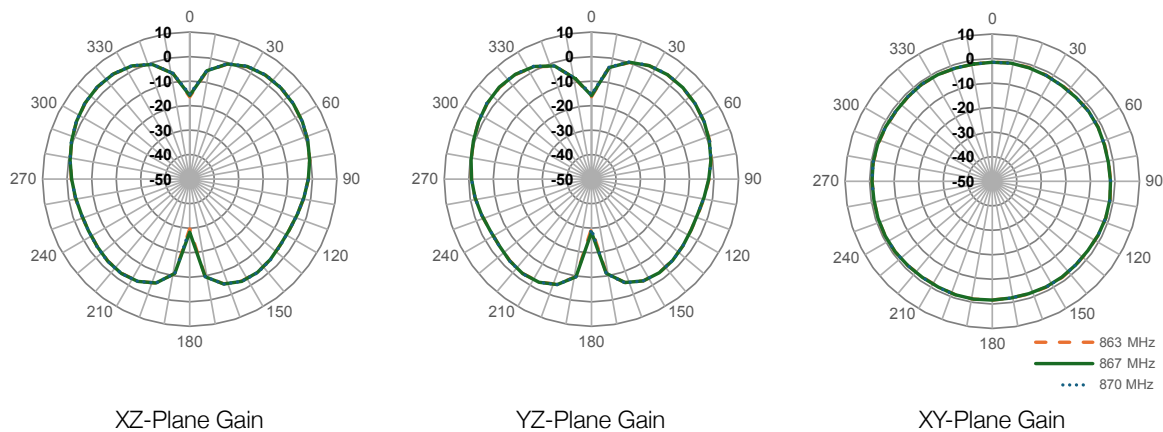

902 MHz to 928 MHz (915 MHz)

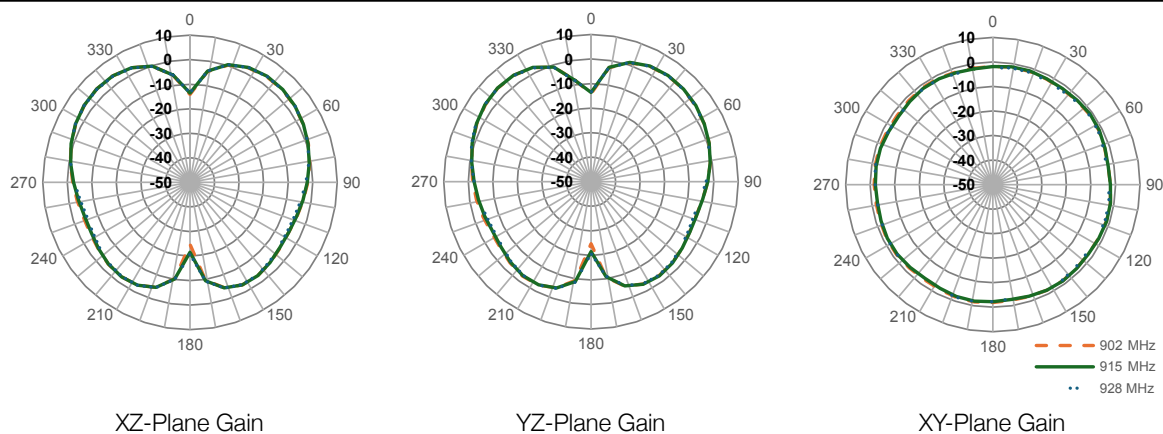

Figure 10. Radiation Patterns for AC65001-NJ Antenna on Ground Plane

Free Space, No Ground Plane

The charts on the following pages represent data taken with the antenna in free space as shown in Figure 11.

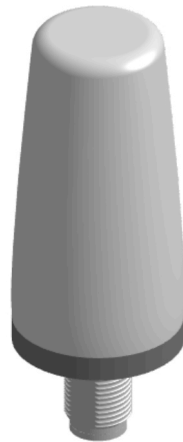

Figure 11. AC65001-NJ Antenna, Free Space, no Ground Plane

VSWR

Figure 12 provides the voltage standing wave ratio (VSWR) across the antenna bandwidth. VSWR characterizes the power reflected from the antenna back to the transmitter. A lower VSWR value indicates better antenna performance at a given frequency. Reflected power is also shown on the right-side vertical axis as a measure of the percentage of transmitter power reflected back from the antenna.

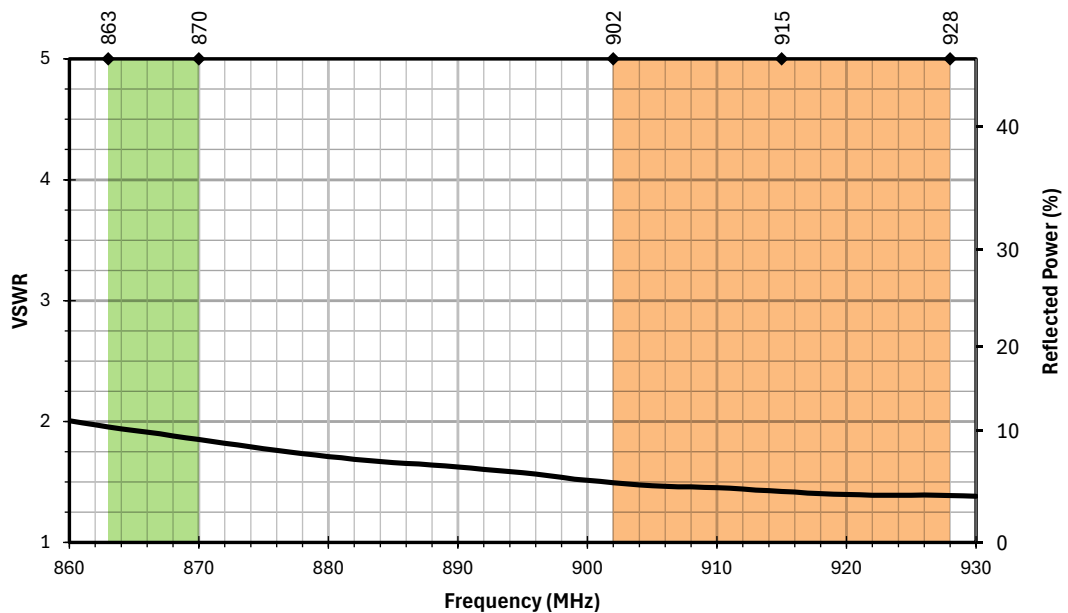

Figure 12. AC65001-NJ Antenna VSWR, Free Space

Return Loss

Return loss (Figure 13) represents the loss in power at the antenna due to reflected signals. A higher magnitude return loss indicates better performance. Return loss is the negative of input reflection coefficient, in decibels (dB), and the two values are often used interchangeably.

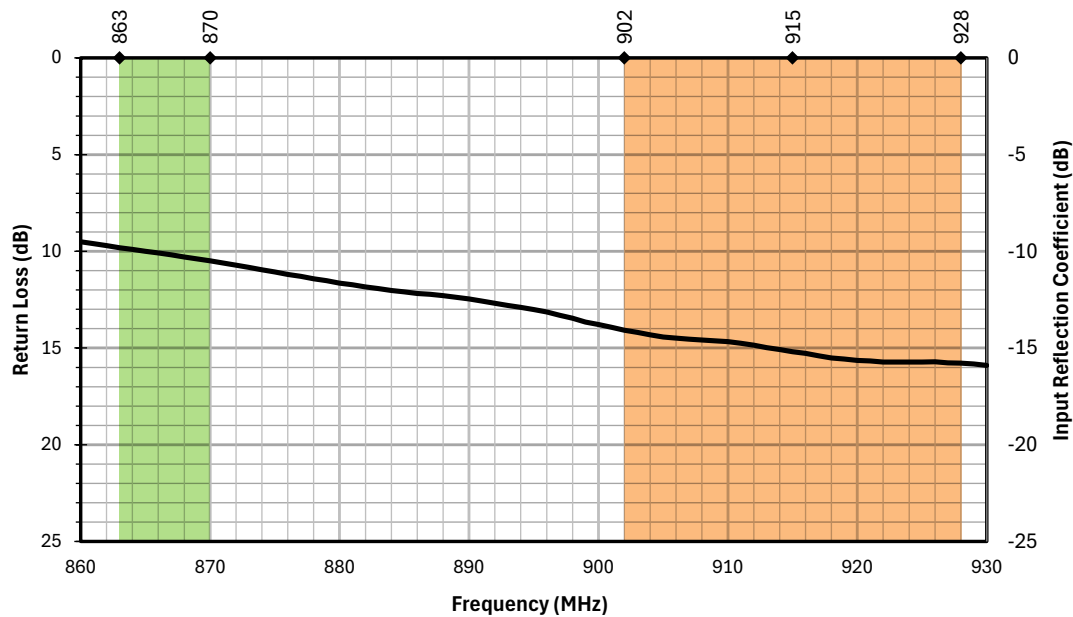

Figure 13. AC65001-NJ Antenna Return Loss, Free Space

Peak Gain

Peak gain (Figure 14) provides a measure of the maximum conversion of antenna input power to radio waves at a given frequency. Peak gain does not account for the directionality of gain in 3-dimensional space.

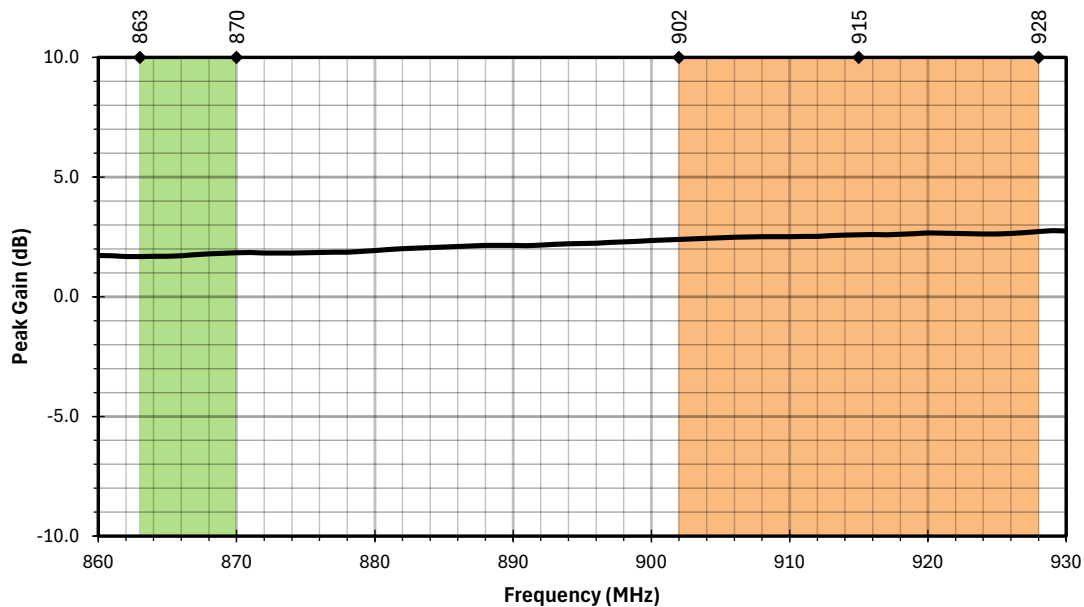

Figure 14. AC65001-NJ Antenna Peak Gain, Free Space

Average Gain

Average gain (Figure 15) is the average of all antenna gain in 3-dimensional space at each frequency, providing an indication of overall performance without expressing antenna directionality.

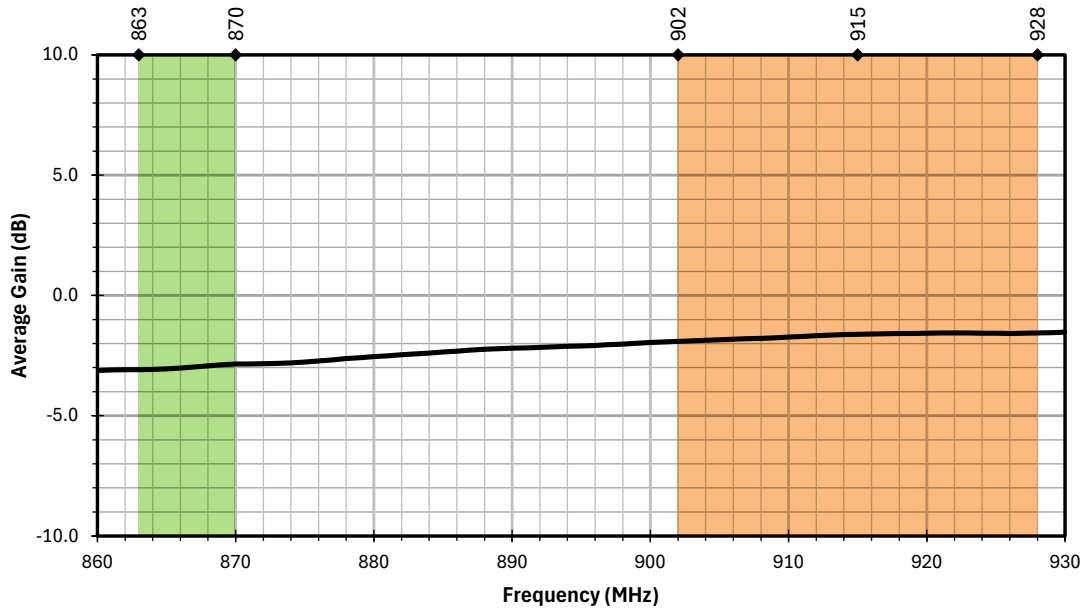

Figure 15. AC65001-NJ Antenna Average Gain, Free Space

Efficiency

Efficiency (Figure 16) is the ratio of power delivered to the antenna relative to the power radiated at the antenna, expressed as a percentage, where a higher percentage indicates better performance at a given frequency.

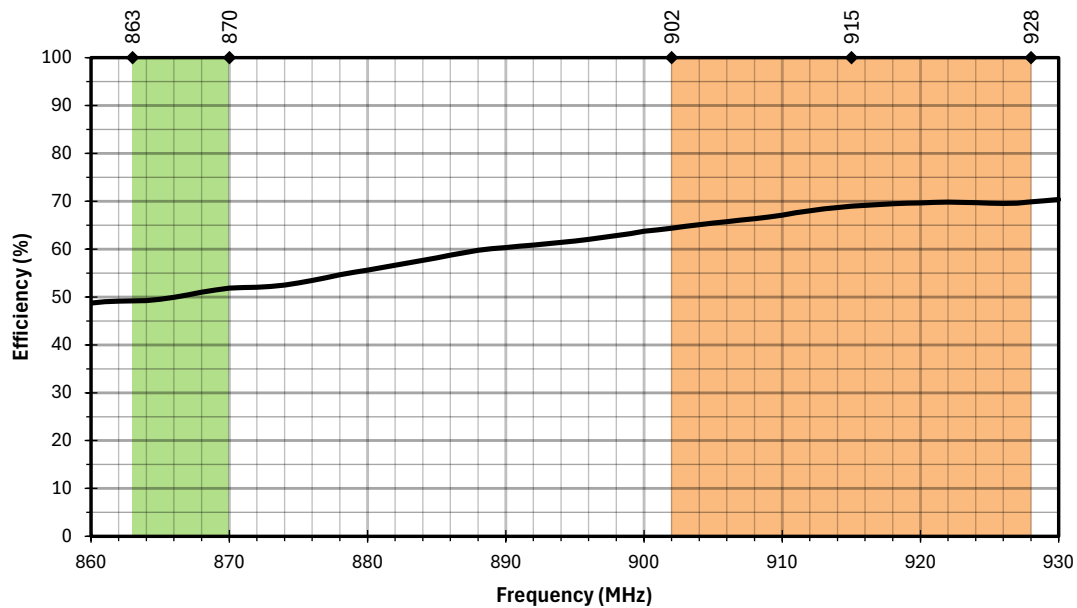

Figure 16. AC65001-NJ Antenna Efficiency, Free Space

Radiation Patterns - Free Space

Radiation patterns provide information about the directional performance of the antenna by plotting gain in three orthogonal planes at the high-, low- and center-frequencies of an antenna frequency band. Antenna radiation patterns (Figure 17) are shown using polar plots covering 360 degrees with the plane of reference depicted above the plots. Note: when viewed with typical PDF viewing software, zooming into radiation patterns is possible to reveal fine detail.



XZ-Plane Gain



YZ-Plane Gain



XY-Plane Gain

863 MHz to 870 MHz (867 MHz)

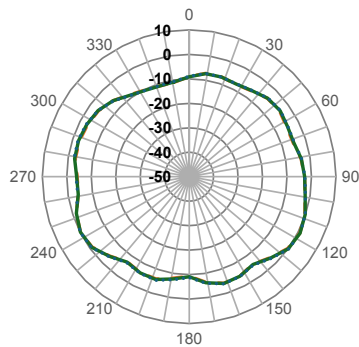

XZ-Plane Gain

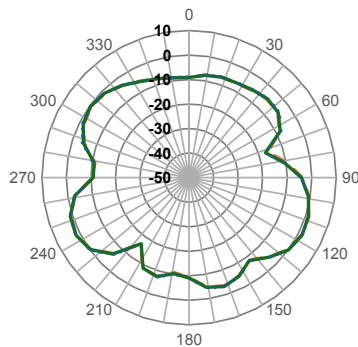

YZ-Plane Gain

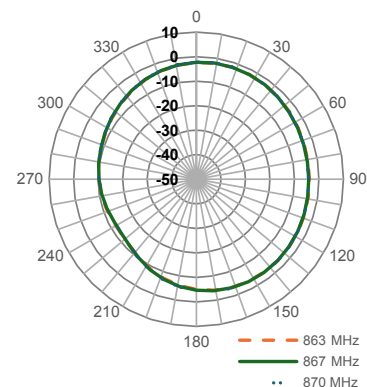

XY-Plane Gain

902 MHz to 928 MHz (915 MHz)

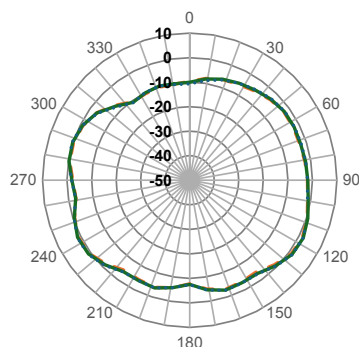

XZ-Plane Gain

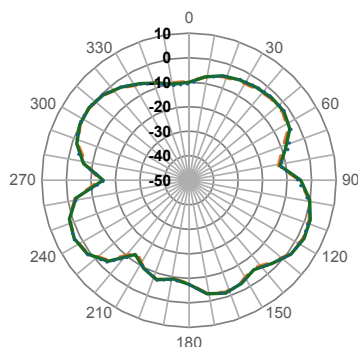

YZ-Plane Gain

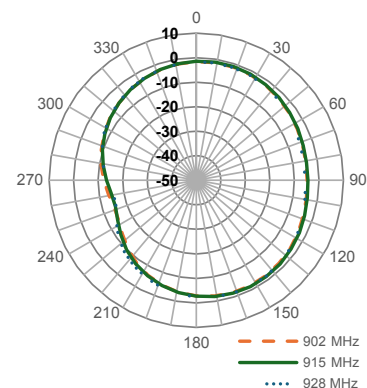

XY-Plane Gain

Figure 17. Radiation Patterns for AC65001-NJ Antenna in Free Space

Packaging Information

The AC65001-NJ antennas are individually packaged in a resealable polyethylene bag. Bagged antennas are placed in “honeycomb” divided pockets in a carton at 100 antennas per carton. 5 layers of 20 antennas per layer. Layers are separated by protective sheets. Carton dimensions are 590 mm x 290 mm x 270 mm (23.23 in x 11.42 in x 10.63 in).

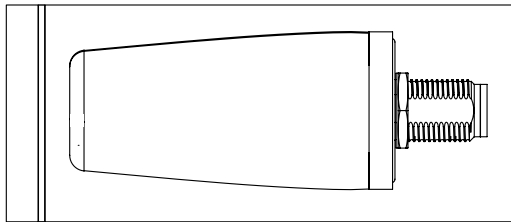

Antenna in resealable bag

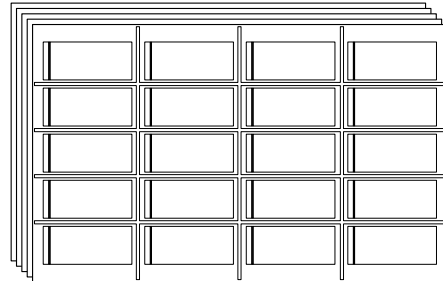

Antennas arranged in layers

Figure 18. Packing Materials and Specifications

Regional Environmental Regulation Compliance

Region	Regulation	Reference
United States	US EPA Toxic Substances Control Act amended December 2020 Declaration	TSCA Section 6(h)
United States	California Proposition 65 Safe Drinking Water & Toxic Enforcement Act of 1986 Declaration	HSC division 20 chapter 6.6
European Union	RoHS 3	EU 2015/863
European Union	EU REACH	EU 1907/2006
Worldwide	Responsible Minerals Initiatives	Dodd Frank act 1502; EU 2017/821
European Union	Persistent Organic Pollutants	(EU) 2019/1021
European Union	Packaging Directive	94/62/EC
European Union	PFOA Free	2006/122/ECOF

Website: <http://www.antennacompany.com>
Offices: Eindhoven, The Netherlands
EMAIL: sales@antennacompany.com

The Antenna Company reserves the right to make changes to the product(s) or information contained herein without notice. No liability is assumed as a result of their use or application. No rights under any patent accompany the sale of any such product(s) or information.

LoRaWAN® is a trademark of the LoRa Alliance®, Wi-Fi HaLow™ is a trademark of the Wi-Fi Alliance®. Other product and brand names may be trademarks or registered trademarks of their respective owners.

Series: Compact Dome

Patent Pending.

Copyright © 2025 The Antenna Company International N.V.

All Rights Reserved

